

We help people do what they love by restoring mobility. We are committed to providing the best customer experience in orthopedics through our premium, clinically-proven products, coupled with unparalleled service and value.

## ORTHOMED E

Orthopedic Implant Manufacture

Orthomed E implants are manufactured with pride using the most advanced materials, latest technologies, and a steadfast commitment to quality.

Patient safety is our top priority, and all product is inspected, cleaned, packaged, and shipped from the company's headquarters in Egypt.

### ORTHOMED E

6<sup>th</sup> of October city, 3<sup>rd</sup> industrial area, 201/3.

Giza - Egypt

Tel. +202 38204966-77

Fax. +202 38204988

Email: [info@orthomed-e.net](mailto:info@orthomed-e.net)

Website: [www.orthomed-e.net](http://www.orthomed-e.net)

### | | | |----|-----| | EC | REP | |----|-----| OBELIS S.A

Bd. General Wahis, 53  
1030 Brussels – Belgium

Tel no: +32 2 732 59 54

Fax no: +32 2 732 60 03

Email: [mail@obelis.net](mailto:mail@obelis.net)

Web: [www.obelis.net](http://www.obelis.net)

Bone Screws



[www.orthomed-e.net](http://www.orthomed-e.net)  
[info@orthomed-e.net](mailto:info@orthomed-e.net)

002 02 3820 4977  
002 02 3820 4988

# Bone Screws

## IFU 001/01



Orthomed E

**Manuals are subject to change; the most current version of each manual is always available online.**

📖 Printed in: **December 24, 2018**

- Orthomed E has a variety of Bone Screws, which classified as Cancellous and Cortical Screws as well washers.
- Components are available in a variety of designs and size ranges intended for stabilization and support of bone structure treatment. They are used for treatment of bone fractures, non-unions, delayed unions, osteotomies and arthrodesis.

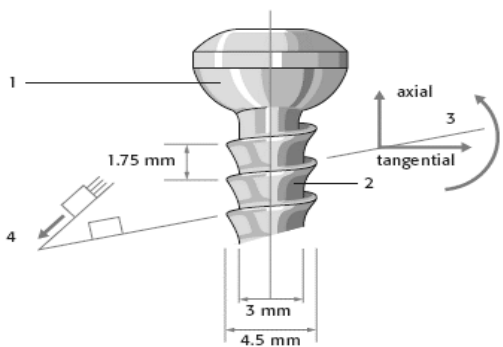

Surgeons will select the design of the bone screws and size to give the range of motion and stability that need to function. There are several different choices of bone plates to consider.

## **MATERIALS?**

Medical grade titanium alloy (TA) per ISO 5832-3/ASTM F136 or Stainless Steel (SS) per ISO 5832-1/ASTM F138.

All of materials we have machined are found acceptable.



## **INDICATIONS!**

The product line of the medical device Bone Screws, which intended to be used for stabilization and support of bone structure treatment. They are used for treatment of bone fractures, non-unions, delayed unions, osteotomies and arthrodesis.

## **CONTRADICTION!**

The choice of particular device must be carefully weighed against patient's overall condition. Conditions listed below may preclude or reduce the chance of successful outcome:

- Infection local to the operative site.
- Signs of local inflammation.

- Fever or leukocytosis.
- Morbid obesity (defined according to the WHO standards).
- Pregnancy.
- Neuromuscular disorders which can create unacceptable risk of fixation failure or complications in postoperative care.
- Any other condition which would preclude the potential benefit of implant insertion surgery and disturb the normal process of bone remodeling, e.g. the presence of tumors or congenital abnormalities, fracture local to the operating site, elevation of sedimentation rate unexplained by other diseases, elevation of white blood cells (WBC) count, or a marked left shift in the WBC differential count.
- Suspected or documented allergy or intolerance to implant materials. Surgeon shall find out if the patient develops allergic reaction to the material of the implant (content of the implant material is presented in Device Description).
- Any case not needing a surgical intervention.
- Any case not described in the indications.
- Any patient unwilling to cooperate with postoperative instructions; mental illness, a condition of senility or substance abuse may cause the patient to ignore certain necessary limitations and precautions in the implant usage.

- Any case where the implant components selected for use would be too large or too small to achieve a successful result.
- Any case that requires the simultaneous use of elements from different systems that are made of different metals.
- Any case in which implant utilization would disturb physiological processes.
- Any case in which there is inadequate tissue coverage of the operative site.
- Blood supply limitation in the operative site.
- The above-mentioned list does not exhaust the topic of contraindications
- During normal use all surgical implants are subjected to repeated stresses which can result in material fatigue and failure of the implant.
- To avoid excessive stress on the implant which could lead to non-union or implant failure and associated clinical problems, the surgeon must inform the patient about the physical activity limitations during the treatment period.
- If the patient is involved in an occupation or activity (e.g.: substantial walking, running, lifting weights, muscles strain) which may apply excessive stress on the implant, the surgeon must inform the patient that resultant forces can cause implant failure.
- A successful result is not always achieved in every surgical case. This fact is especially true in the case where other patient's conditions may compromise the results.
- The proper patient selection, compliance of the patient and observance of post-operative recommendations will greatly affect the results. The bone union is less likely to occur among patients who smoke. These patients should be informed about this fact and warned of this consequence.
- Overweight may cause additional stresses and strains within implant which can lead to fatigue and deformation of the implant.
- Patients who are overweight, malnourished and/or abusing alcohol or drugs, with weak muscles and low-quality bones and/or with nerve palsy are not the best candidates for the procedure of surgical stabilization. These patients are not able or not ready to observe the post-operative recommendations and limitations.
- The implants are intended as an aid to the healing process and are NOT intended to replace body structures or bear the body weight when the treatment process has not yet finished.
- The implant may break or become damaged as a result of strenuous activity or trauma and may need to be replaced in the future.
- The surgeon must warn the patient that the device cannot and does not restore the function and efficiency of a healthy bone.
- In the case of delayed union or non-union, the load or weight bearing may eventually cause the implant bending, loosening, disassembling or fatigue breakage

## **WARNINGS!**

---

The important medical information given in this document should be conveyed to the patient.

- The selection of proper shape and size of the implant appropriate for a specific patient is crucial to achieving success of the surgery. The surgeon is responsible for this choice.
- Preoperative and operating procedures, including knowledge of surgical techniques, and correct placement of implants are important and shall be considered by the surgeon in order to achieve success during operation.
- No implant can withstand body loads without the biomechanical continuity of the bone.

## **PRECAUTIONS!**

---

- Implant is intended for single use only. After removing the implant from the patient's body, it must be secured against re-use, and then finally disposed of in accordance with current hospital procedures.

- Under no circumstances is it allowed to reuse, or re-implant once used device. Even if the removed implant appears to be undamaged, it may have small latent defects or internal stresses, which could lead to early failure, fatigue wear, and as a result to e.g.: an implant breakage.

**Note:**

Not used refers to those single-use components that have not been in contact with blood, bone, tissue, or other body fluids. Any unused, single-use device that has been exposed to blood, bone, tissue, or body fluids must not be reprocessed and must be discarded.

- Implant which had contact with tissues or body fluids of another patient cannot be re-implanted due to a potential risk of cross-infection caused by viruses, bacteria and prions.
- Misuse of instruments or implants may cause injury to the patient or operative personnel.
- Avoid damaging implant surface and deforming its shape during the implantation; the damaged implant cannot be implanted or left in the patient's body.
- Insertion, removal and adjustment of implants must only be done with instruments specially designated for those implants.
- Use of implants and instruments in combination with implants and instruments from other manufacturers may cause damage or failure of those implants or instruments and may lead to improper course of surgery and healing process.

- While rare, intraoperative fracture or breakage of the instrument can occur. Instruments which have been subjected to prolonged use or excessive force are more susceptible to fractures, depending on care taken during surgery, number of procedures performed, and attention paid. Instruments should be examined for wear or damage prior to surgery.
- Orthopedic surgeons always investigate the possibility of osteoporosis in older patients with fracture due to minor trauma such as a fall from standing height to the floor. Patients with osteoporotic fractures are among the highest risk patients for further osteoporotic fractures, often within 1 year of the fracture. The surgeon's responsibilities include the following:
  - Inform the patient about the need for an osteoporosis evaluation. The orthopedic surgeon should have a basic understanding about osteoporosis and its treatments.
  - Investigate whether osteoporosis is an underlying cause of the fracture. The evaluation should include a clinical history of risk factors and bone mineral density (BMD) assessment, as appropriate.
  - Ensure that appropriate intervention is initiated. The orthopedic surgeon should ensure that an osteoporosis evaluation is done, and appropriate intervention taken.
- While inserting the screw, it is essential to correctly set the screwdriver in relation to the screw. Following the instructions given

allows for reduction of the risk of mechanical damage to the screw, screwdriver, or bony hole:

- screwdriver should be set in the screw axis,
- apply proper axial pressure to ensure that the screwdriver goes as deep in the head of the bone screw as possible,
- the final phase of tightening shall be performed carefully.

## WHAT HAPPENS BEFORE SURGERY?

---

- Patients' conditions and/or predispositions such as those addressed in the above-mentioned CONTRADICTION should be avoided.
- Before deciding about implantation, the surgeon shall inform the patient about indications and contraindications of such procedure and possibility of complications occurrence after the operation. Patient shall be introduced to the purpose and manner of the procedure, and to functional and aesthetic effects of such treatment.
- Proper clinical diagnosis and accurate operation planning and performance are needed to achieve good final result of treatment.
- Where material sensitivity is suspected, appropriate tests should be made prior to material selection or implantation.

- The implantation shall be carried out by the surgeon familiar with adequate rules and operating techniques, and who has acquired practical skills of using instrument set. The selection of surgical technique adequate for a specific patient remains surgeon's responsibility.
- The operation procedure shall be carefully planned. The size of implant should be determined prior to the beginning of the surgery. An adequate inventory of implants with required sizes should be available at the time of surgery, including sizes larger and smaller than those expected to be used.
- The surgeon should be familiar with all components of the implant system before use and should personally verify if all components and instruments are present before the surgery begins.
- Do not use the implant if the original, sterile packaging is damaged. Sterility cannot be guaranteed if the packaging is not intact. The packaging shall be carefully checked prior to use.
- Implants are delivered in protective packages. The package should be intact at the time of receipt.
- Before procedure begins, all implants should be carefully checked to ensure that there is no damage (surface scratching, dents, signs of corrosion and shape deformations). Damaged implant cannot be inserted into the body.

## WHAT HAPPENS AFTER SURGERY?

---

- It is essential to follow all of physician's postoperative directions and warnings.
- It is essential to confirm proper position of the implant by roentgenographic examination.
- In postoperative period, in treatment, the correctness of implant positioning and immobilization of union should be confirmed by roentgenographic examination.
- The patient should be warned about the risk should he fail to follow the above-mentioned rules, or should he be unavailable for follow-up clinical examination.
- The surgeon must instruct the patient to report any unusual changes of the operative site to his/her physician. If any change at the site has been detected, the patient should be closely monitored.
- The patient should be informed about the type of implant material.
- The patient should be warned to inform the medical staff about the inserted implants prior to any MRI procedure.
- The patient should be advised not to smoke or consume alcohol excessively during the period of treatment.
- If the patient is involved in an occupation or activity which may apply excessive stress on the implant (e.g. substantial walking, running, lifting, or muscle strain) the surgeon must advise the patient that resultant forces can cause implant failure.

- The surgeon must instruct the patient regarding appropriate and restricted activities during consolidation and maturation of the fusion mass in order to prevent placing excessive stress on the implants which may lead to fixation or implant failure and further clinical problems. The implant may break or become damaged as a result of strenuous activity or trauma and may need to be replaced in the future.
- Failure to perform appropriate immobilization of bone when delayed or non-union occurs may lead to excessive fatigue stresses in the implant. Fatigue stresses may be a potential cause of implant becoming bent, loosened or fractured. If non-union of fracture or implant bending, loosening or fracture occurs, the patient should be immediately revised, and the implants should be removed before any serious injuries occur. The patient must be appropriately warned about these risks and closely monitored to ensure compliance during the treatment until the bone union is confirmed.

## IMPLANT REMOVAL AFTER TREATMENT

---

- When bone union is achieved, the implants serve no functional purpose and their removal is recommended. The possibility of another surgical procedure and associated risks must be analyzed and discussed with the patient. The final decision on implant removal is up to the surgeon. In most



patients, removal is indicated because the implants are not intended to transfer forces developed during normal activities.

- If the device is not removed following completion of its intended use, one or more complications may occur, in particular:
- Corrosion, with localized tissue reaction or pain.
- Migration of the implant, possibly resulting in injury.
- Risk of additional injury from postoperative trauma.
- Bending, loosening, or breakage, which could make implant removal difficult or impossible.
- Pain, discomfort, or abnormal sensation due to the presence of the implant.
- Increased risk of infection.
- Bone loss due to the stress shielding.
- Potentially unknown and/or unexpected long-term effects.
- Implant removal should be followed by adequate postoperative management to avoid fracture, re-fracture, or other complications.

## **MAGNETIC RESONANCE COMPATIBILITY!**

---

- Orthomed E implants made completely from or containing elements made of implantable steel were not assessed for their safety and compatibility with magnetic resonance

imaging procedures. The performance of MRI on these implants (especially in the magnetic field with a significant induction) may pose a potential risk of, i.e.:

- implant displacement or heating up,
- artifacts on MR images.
- Implants made of titanium are conditionally compatible with magnetic resonance imaging.
- The patient can be scanned under the following conditions:
  - static magnetic field of  $\leq 3$  Tesla,
  - maximum magnetic field spatial gradient of  $\leq 720$  Gauss/cm,
  - maximum MR system reported whole-body-averaged specific absorption rate (SAR) of 3W/kg for 15 minutes of scanning.

### **CAUTION:**

*The user should be absolutely familiar with the contraindications and warnings established by the manufacturer of the MRI scanner to be used for imaging procedure.*

- MR imaging may be interfered with if the area of interest is in the exact same area or relatively close to the position of the implant.
- Do not perform MRI if there are doubts about the tissue integrity and the implant fixation or if the proper location of the implant is impossible to be established.

## **PACKAGING AND STORAGE!**

---

- Implants are single-use devices, provided non-sterile.
- The unit package contains: Non-sterile version - one piece of the product. Clear plastic bags are a typical packaging material.
- The packaging is equipped with the product label. The label (as a primary label) contains e.g.: for Non-sterile product
  - Logo Orthomed-E and the address of the manufacturer.
  - Name and size of the device.
  - Production batch number (LOT), e.g. XXXXXXXX.
  - Material of the implant (see IMPLANT MATERIAL).
  - Non-Sterile sign - indicates sterile product.
  - Device pictogram and information symbols
- In addition to the device primary label, an auxiliary label with specific market requirements of a given area may be placed on the unit package (e.g. legal requirements of the country in which the device will be distributed).
- The package may contain: Instructions for Use and labels to be placed in a patient's medical record.
- Implants should be stored in appropriate protective packages, in a clean, dry place with a moderate temperature and under

conditions that provide protection from direct sunlight.

## **IMPLANTS PROVIDED NON-STERILE!**

---

- Prior to use of a non-sterile device the following rules apply:
  - The device must undergo washing, disinfection and sterilization procedures. It is recommended to use automated procedures for washing and disinfecting in the washer-disinfector.
  - Effective cleaning is a complicated procedure depending on the following factors: the quality of water, the type and the quantity of used detergent, the technique of cleaning (manual, ultrasound, with the use of washing/disinfecting machine), the proper rinsing and drying, the proper preparation of the device, the time, the temperature and carefulness of the person conducting this process.
  - Labels to be placed in patient's medical records (delivered together with the implant) must be protected against loss or damage during the implant washing and sterilization.
  - The hospital facility remains responsible for the effectiveness of the conducted cleaning, packaging and sterilization processes with the use of existing equipment, materials and properly trained personnel.
- **Preparation for washing**
  - After taking the device out from the original package, remove possible surface contamination (resulting from e.g.: damage to unit package) using a disposable cloth, paper towel or plastic brushes (nylon brushes are recommended). Do not use brushes made of metal, bristles or materials which could damage the implant.
- **Cleaning and disinfection process**
  - The chosen washing and disinfecting detergents must be suitable and approved for use with medical devices. It is important to follow the instructions and restrictions specified by the producer of those detergents. It is recommended to use aqueous solutions of washing-disinfecting agents with a pH value between 7 and 10.8.
- **Manual cleaning**
  - Apply washing detergent to implant surface and brush carefully. Suitable brushes must be used for holes cleaning.
  - If applicable, ultrasonic cleaning may be performed. The ultrasonic bath must be prepared according to the manufacturer's instructions.
  - Rinse thoroughly under running water. It is recommended to rinse with demineralized water.
  - Visually inspect the entire surface of the device for damage and contaminants. Damaged implants must be removed.
- For contaminated implants, the cleaning process should be repeated.
- **Cleaning in the washer-disinfector**
  - The device should undergo a process of machine washing in the washer-disinfector (use washing-disinfecting agents recommended for medical devices). CAUTION: The equipment used for washing/disinfection should meet the requirements of EN ISO 15883.
  - Procedure of washing in the washer-disinfector shall be performed according to internal hospital procedures, recommendations of the washing machine manufacturer, and instructions for use prepared by the washing disinfecting agent manufacturer. Disinfection should be carried out at temperature of 90°C (soak in demineralized water) for at least 10 minutes without the use of detergents.
- **Drying**
  - Drying of the device must be performed as a part of the washing/disinfection process.
- **Packaging**
  - The device supplied non-sterile must be repacked in a packaging intended for a specific sterilization method that meets the requirements of EN ISO 11607-1. The packaging procedure must be performed in controlled purity conditions. The device must be packed in such a way that during removal from the package, when used, there is no risk

for its contamination. Sterilization package is designed to maintain the sterility of medical devices after the sterilization process and during their storage prior to use.

- **Sterilization**

- Washed, disinfected, and dried device shall undergo the sterilization process. The recommended method of sterilization is vacuum-type steam sterilization (with water vapor under overpressure):
  - temperature: 134°C,
  - minimum exposure time: 7 min,
  - minimum drying time: 20 min.

**CAUTION:**

- Sterilization must be effective and in accordance with requirements of the EN 556 standard to ensure the required level of guaranteed sterility SAL 10-6 (where SAL stands for Sterility Assurance Level).
- Implant must not be sterilized in the package in which it was delivered.
- Validated sterilization methods used by sterilization facilities are allowed.
- The above-mentioned rules of cleaning and sterilization must be followed when dealing with any device intended for implantation.

**RE-STERILIZATION!**

---

The adverse effects may necessitate It is permitted to re-sterilize devices by end-user

**ATTENTION:** The user of the product bears all responsibility for re-sterilization. In such case the device shall be washed and sterilized in a way described in Instruction for Reusable Orthopedic Implants.

**ADVERSE EFFECTS!**

---

- The adverse effects may necessitate reoperation or revision. The surgeon should warn the patient about the possibility of adverse effects occurrence. The undermentioned list does not exhaust the topic of adverse events. There is a risk of occurrence of adverse events with unknown etiology which may be caused by many unpredictable factors. Potential adverse events include but are not limited to:
  - Implant damage (fracture, deformation or detachment).
  - Early or late loosening, or displacement of the implant from the initial place of insertion.
  - Possibility of corrosion as a result of contact with other materials.
  - Body reaction to implants as foreign bodies e.g. possibility of tumor metaplasia, autoimmune disease and/or scarring.
  - Compression on the surrounding tissue or organs.
  - Infection and/or Death.
  - Bone fractures or “stress shielding” phenomenon causing loss of bone above, below or at the operative site.

- Hemorrhage of blood vessels and /or hematomas.
- Pain and/or Inability to perform everyday activities.
- Mental condition changes. Deep vein thrombosis, thrombophlebitis.
- Occurrence of respiratory complications, e.g.: pulmonary embolism, atelectasis, bronchitis, pneumonia, pulmonary infection, disturbed lung growth, respiratory acidosis, etc.
- Scar formation that could cause neurological impairment, or nerves compression and /or pain.
- Late bone fusion or no visible fusion mass and pseudarthrosis. Loss of proper curvature & length of bone.

**Make Attention Here!👇**















---

Patient’s age, weight, activity level, etc. influence the service life of the implant. Normally, for implantable Stainless-Steel implant e recommend being removed after period of not more than two years after its implantation and it can last for upwards of 20 years for implantable Titanium implants.

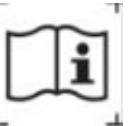

## SYMBOLS ON THE LABELS!

---

		
Manufacturer	Authorized representative	Date of manufacture
		
Use-by date	Catalogue number	Batch code
		
Non-sterile	Do not re-use	Do not use if package is damaged
		
Keep away from sunlight	Temperature limit	Keep dry
		
Consult instructions for use	Caution	0120